

Multi-Purpose High-Speed Centrifuges

www.gyrozen.com



GYROZEN[®]

GYROZEN®



Contents

04... Features of GYROZEN Multi-Purpose Centrifuges

06... Medium Capacity Centrifuges
1248 / 1248R / 1236R

08... Super Performance Centrifuges
1580 / 1580R

12... Rotors and Accessories

18... Ordering Information

19... Related Products

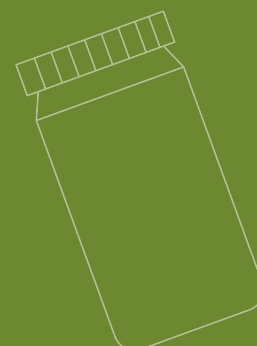
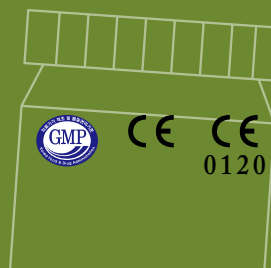

0120



GYROZEN offers an extensive centrifuge portfolio.

GYROZEN centrifuge offers many unique features of safety, robustness, and convenience in operation and is furnished with automatic rotor identification, imbalance cut-off, anti-vibration structure, soft touch lid closure, intuitive control panel, etc. From compact bench-tops to movable floor models with a large assortment of rotors, buckets and accessories, GYROZEN provides you with the freedom of choosing an ideal centrifuge to meet your needs. Five models of multi-purpose, high-speed centrifuges - 1248, 1248R, 1236R, 1580, and 1580R - share rotors (G-family), buckets, and accessories so as to save money and space. With GYROZEN centrifuges, you can enjoy daily laboratory work to its fullest.

www.gyrozen.com

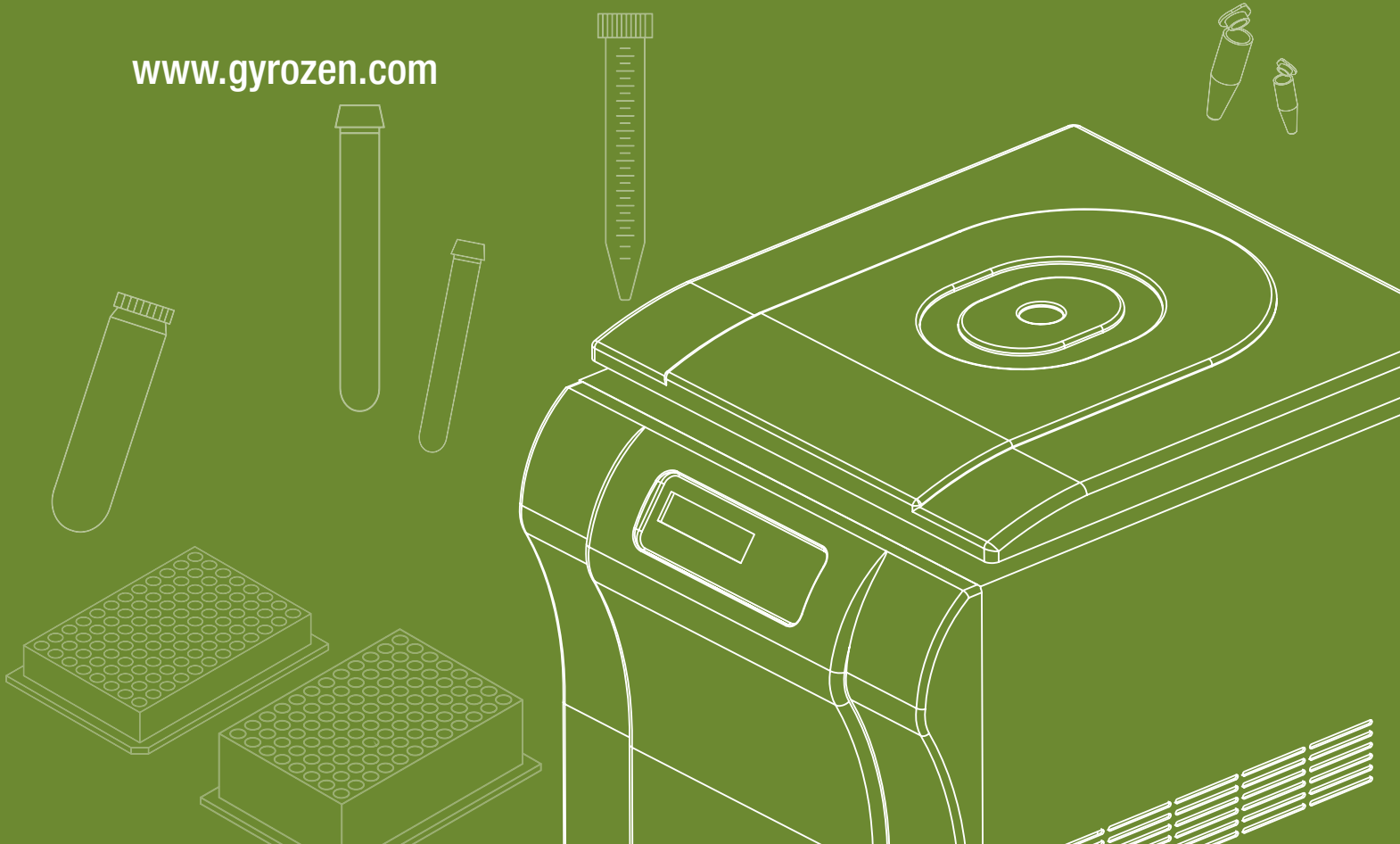

Designed to match your needs

Advanced Safety and Robustness

GYROZEN guarantees the highest possible lab standards that you require for your daily work with industry-leading safety and quality.



Automatic rotor identification
protects its operator and instrument from improper rotation.



Imbalance cut-off
and accompanied alarm keep the instrument protected from unsuitable operation.



Very quiet operation
at less than 60 dB allows for comfortable laboratory environment.



Key lock function
helps set-parameters secured while running.



Fast-cooling function
to 4°C in 5 minutes for fast start up and fast cooling-down of samples.



Compressor-off function
during lid-open minimizes frosting and rusting.



Lid drop protection scheme
allows for easiness and safety when loading and unloading.



Soft touch lid closing
of motorized lid offers its operator comfort.



Glove-friendly, easy-to-input touch buttons



Automatic rotor identification for safe operation



Ergonomic design for easy operation

Advanced Convenience in Operation

GYROZEN's multi-purpose, high-speed centrifuge series features easy-to-use controls on a wide range of operating parameters and processing statuses. A large assortment of rotors with buckets and adaptors is ideal for application versatility.



Intuitive interface with numeric input buttons

allows easy setting and editing of running conditions.



Soft touch panel

is highly sensitive to input parameters and supports life extension of the control panel.



Automatic RPM/RCF conversion

for easy detection of g-value forced to samples



Fine control of ACC/DEC ramps

is suitable for delicate separation control (The DEC 0 for zero brake deceleration).



Up to 100 programs

Convenient operation of user-defined protocols



Time mode selection

of "At Set Speed" is for timed runs at the set speed



A large assortment of rotors, buckets and adaptors

supports diverse applications doable with an instrument.



End alarm management

allows variable end alarms to be switched by user preference

Medium Capacity, Multi-Purpose Centrifuges

1248R

12,000 rpm

16,582 xg



1248

12,000 rpm

15,520 xg



1248, 1248R and 1236R

The 1248 and 1248R are compact Benchtop centrifuges whereas the 1236R is floor standing. All of these models go up to 12,000 rpm and the maximum loading capacity is 1 liter. The floor standing model, 1236R, has 4 casters at the bottom of the body; it can be easily moved and positioned and safely locked, which enables you to make better use of lab space. Also, the working height of 84 cm (33 inches) ensures ergonomic operation and allows you to easily load and unload sample tubes. The 'R' models are equipped with a powerful refrigeration system that allows the temperature to cool down to 4°C from room temperature within 5 minutes.

These models are ideal for cell culture application, clinical preparation, molecular biology work, food science, etc.

The 1248, 1248R and 1236R are medium capacity (up to 4 x 250 ml) centrifuges. For cell harvesting, blood separation, and washing or spin down of microplates, the following swing rotors are commonly used. More rotors and accessories for diverse applications are described on page 12.

1236R

12,000 rpm

16,582 xg



Four lockable and leveling casters

- Free movement for saving space
- Stable stand of balanced status

[Best Selling Rotors]

Four-wing rectangular 250 ml swing-out rotor GRS-G-r250-4

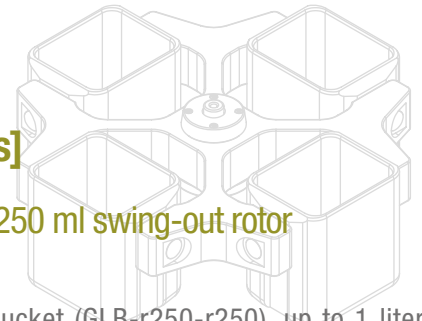

With rectangular 250ml bucket (GLB-r250-r250), up to 1 liter centrifugation is possible at a time. Together with appropriate tube adaptors, most of separation required in a laboratory can be carried out. When using a microplate holder, it supports 16 normal microplates or 4 deepwell plates. The speed choice of 500 rpm makes mild and stable separation possible, especially for micro or nano-particle application.

Four-wing round 250 ml swing-out rotor GRS-G-250-4

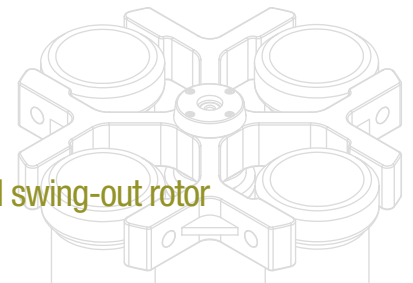

By matching with four different buckets, this rotor supports diverse applications such as blood separation through 60/20/10 ml syringes, cell collection, component separation of bio samples and food samples, etc. The maximum speed of 5,000 rpm (about 5,400 xg) extends its application limit.

Six-wing round 100 ml swing-out rotor GRS-G-100-6

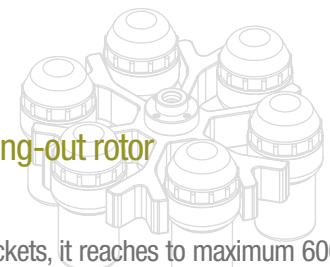

With the O-ring sealed 100 ml buckets, it reaches to maximum 600 ml separation of samples under the simultaneous protection of the operator and environment. From microtubes to 100 ml tubes, the O-ring sealed 100 ml bucket is supplied with 10 different tube adaptors. With the uniquely designed vacutainer bucket, GLB-10-8-100, fast separation of 48 blood samples is easily achieved.

Super Performance on the Bench-top

1580 and 1580R

The 1580 and 1580R multi-purpose 3L capacity centrifuges are designed for large-volume daily-working laboratories to save time with streamlining processes. These models go up to 15,000 rpm with high throughput capacity and offer a great variety of rotors for diverse applications. The 1580R is equipped with a powerful refrigeration system allowing the temperature to cool down to 4°C from room temperature within 5 minutes. Therefore, within few minutes, you are ready to load your valuable samples at a desired temperature and process centrifugation right away.

These models are ideal for cellular and molecular biology work, clinical preparations, nano-particle separations, industrial applications, etc. You can enjoy a variety of different laboratory work with a single instrument.



1580R

15,000 rpm

25,910 xg



Intuitive Control Panel with Soft Touch Key

- > Highly sensitive to input parameters and supports life extension of the control panel
- > Fast input of parameters through the numeric key buttons
- > Extended functions for the management of time duration, end alarm and key lock

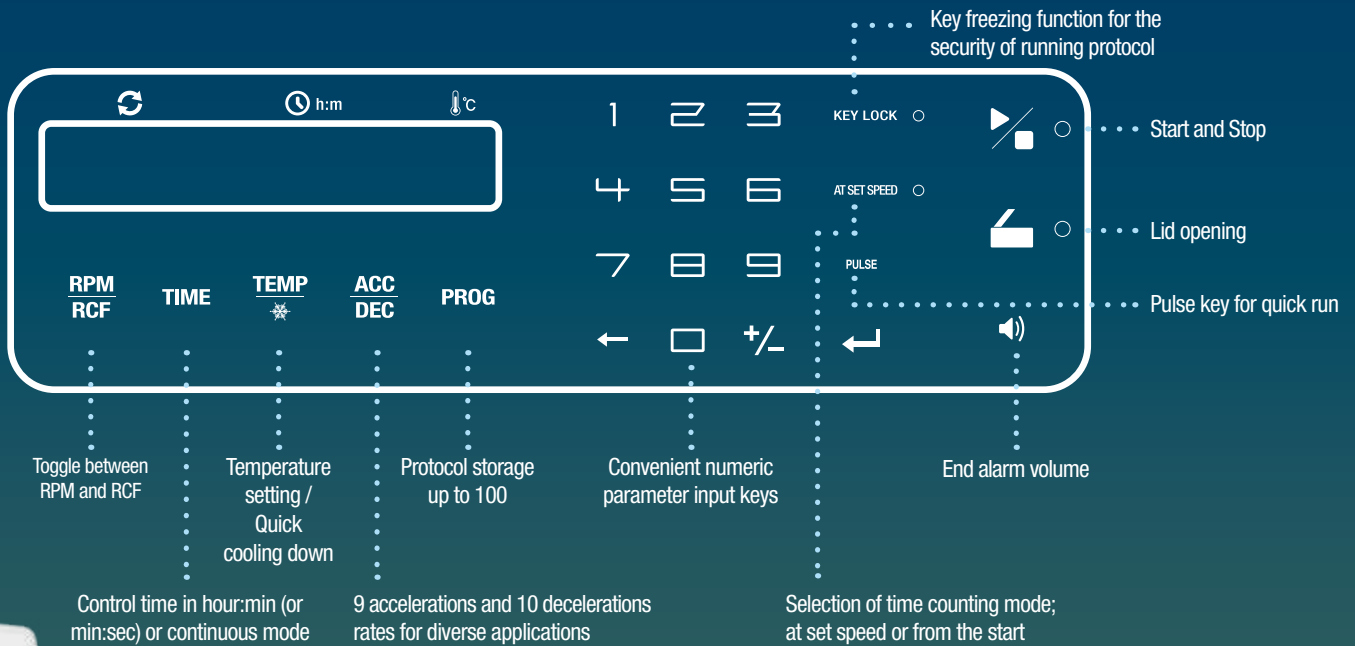

1580

15,000 rpm

24,249 xg

Just use your sample tubes.
We support your experiments with various tube adaptors!



The high-throughput feature of the 1580 series comes from two big swing rotors of GRS-G-r750-4 and GRS-G-750-4 for four rectangular 750 ml and four round 750 ml respectively. The immediate separation of 120 vacutainer samples or small tubes is feasible with rectangular 750 ml rotor and buckets. With round 750 ml rotor and buckets, more diverse experiments can be designed through a variety of tube adaptors of multi and single tubes at up to 4,000 rpm (max. 3,900 xg). For large volumes of cell harvesting, a fixed angle rotor, GRF-G-250-6, is recommended for reaching up to 8,000 rpm and 1.5 L volume at a time. For micro-particle separation and nucleic acid precipitation, the fixed angle rotors, GRF-G-50-8 and GRF-G-m2.0-30 are ideal for driving up to 15,000 rpm.

Find more multi-purpose applications with our rotors and accessories on page 12.

[Best Selling Rotors]

Four-wing round 750 ml swing-out rotor GRS-G-750-4

Matching with four round O-ring sealed 750 ml buckets (GLB-b750-750), any samples are safely centrifuged at up to 4,000 rpm. The round 750 ml bucket is provided with many different tube adaptors. Using microplate holders, 500 ml buckets, and no-cap round 750 ml buckets in this rotor, your choice of sample containers and applications can be extended.

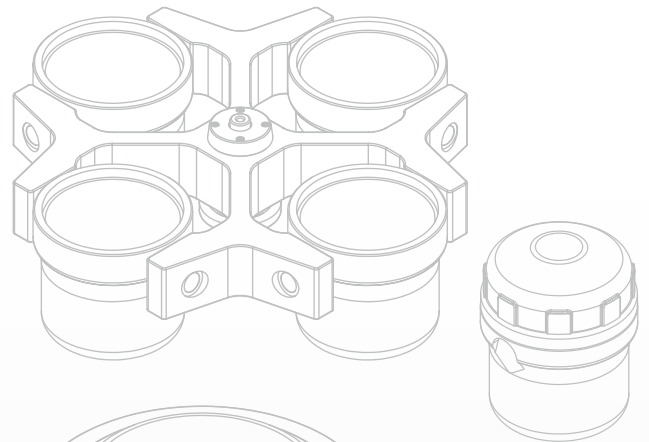

Six-hole 250 ml fixed angle rotor GRF-G-250-6

Designed for large-volume cell harvesting, (1.5L at a time), the additional 6 holes for 15 ml tubes help concurrent separation of large and small samples in a single run.

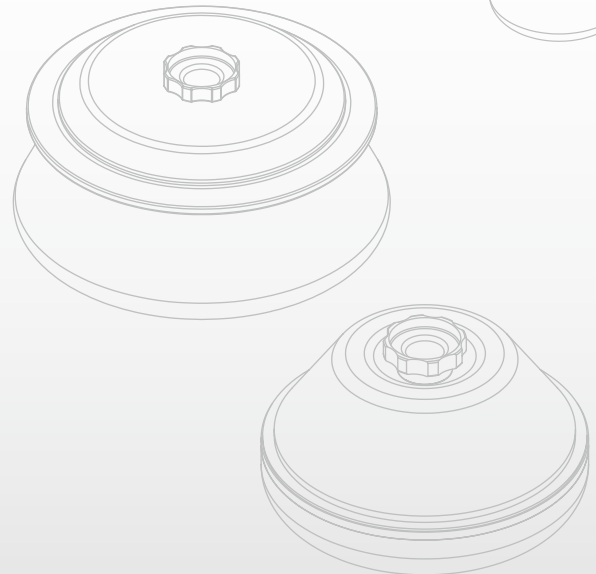

Six-hole 85 ml fixed angle rotor GRF-G-85-6

This fixed angle rotor makes diverse applications practical at high speed up to 12,000 rpm (17,709 xg). Provided with a number of adaptors for 50 ml and 15 ml tubes, application efficiency is higher than with two or three rotors. The rotor itself is light and autoclavable.

•••••••• Applicable Containers

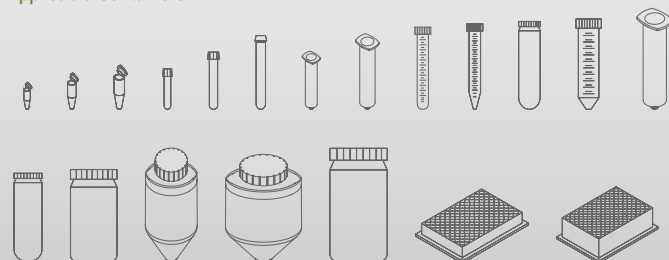



Assorted collections of tube adaptors support extended usage of single rotor or bucket. Find adequate adaptors from the rotor descriptions on pages 13~17.

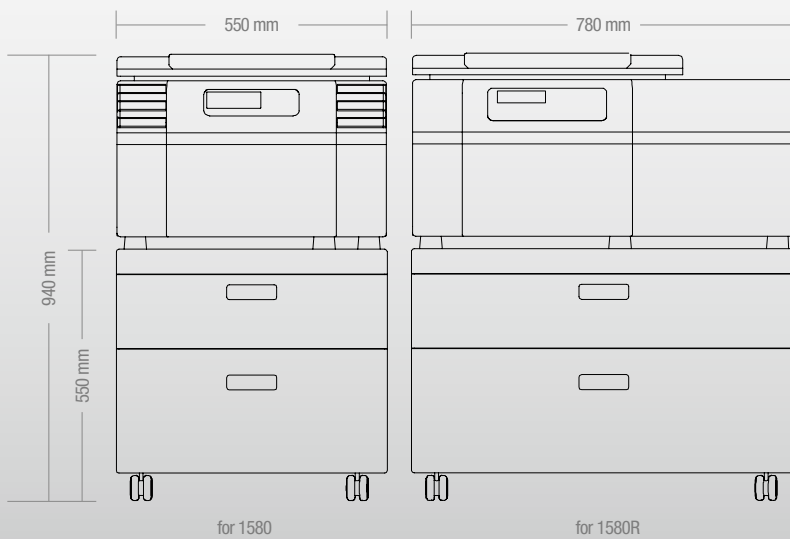

Lockable Table for Centrifuge with 2 Drawers

Select rotors to meet your needs.

GYROZEN rotors are designed for ensuring safety and long life. All rotors are autoclavable and corrosion resistant.

A large assortment of rotors, fixed angle or swing-out with buckets and tube adaptors offers the freedom of finding the best fitted vehicle for any purpose of centrifugation.

Cat. No.

Max. RPM

Applicable tubes



GRS-G-r750-4

with GLB-r750-r750

3,600 rpm
3 ~ 500 ml (C), MTP
p.13

Only for 1580R, 1580



GRS-G-750-4

with GLB-b750-750

4,000 rpm
3 ~ 750 ml, MTP
p.13

Only for 1580R, 1580



GRS-G-r250-4

with GLB-r250-r250

4,000 rpm
3 ~ 250 ml, MTP
p.14



GRS-G-250-4

with GLB-250-250

5,000 rpm
10 ml syringe ~ 250 ml (C)
p.14



GRS-G-100-6

with GLB-b100-100

4,000 rpm
1.5 ~ 100 ml
p.15



GRF-G-250-6

8,000 rpm
15 ml and 250 ml
p.15

Only for 1580R



GRF-G-85-6

12,000 rpm (1580R)
10,000 rpm (1236R/1248/1248R/1580)
10 ~ 85 ml
p.16



GRF-G-50-8

15,000 rpm (1580R)
12,000 rpm (1236R/1248R/1580)
10 ~ 50 ml
p.16



GRF-G-15-24

8,000 rpm
15 ml
p.16

Only for 1236R, 1248R, 1580R



GRA-G-15-24A

4,000 rpm
3 ~ 15(C) ml
p.17



GRF-G-m2.0-30

15,000 rpm (1580R/1580)
12,000 rpm (1236R/1248R/1248)
0.2 ~ 2.0 ml
p.17



GRF-G-s0.2-64

12,000 rpm
0.2 ml 8-tube PCR strip
p.17

Swing-out Rotor, GRS-G-r750-4

4 loadings, 90° | for 1580, 1580R

Bucket, GLB-r750-r750

3,600 rpm / 2,898 xg



Bucket, GLB-500-r750

3,600 rpm / 3,159 xg



Microplate Holder, GLP-mw-r750

3,600 rpm / 2,485 xg

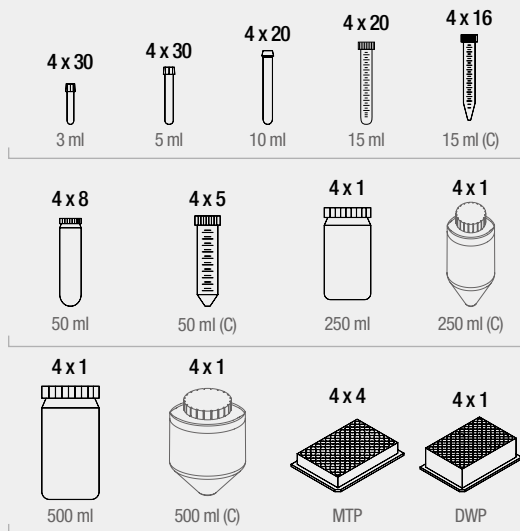

Tube Racks and Adaptors for GLB-r750-r750



GAM-5-30(r750)
30 x 3/5 ml



GAM-15-20(r750)
20 x 10/15 ml



GAM-c15-16(r750)
16 x 15 ml (C)



GAM-50-8(r750)
8 x 50 ml



GAM-c50-5(r750)
5 x 50 ml (C)



GAS-250(r750)
250 ml



GAS-c250(r750)
250 ml (C)



GAS-c500(r750)
500 ml (C)

Swing-out Rotor, GRS-G-750-4

4 loadings, 90° | for 1580, 1580R

Bucket, GLB-750-750

4,000 rpm / 3,667 xg



Bucket, GLB-b750-750 with O-ring sealed Cap

4,000 rpm / 3,667 xg



Bucket, GLB-500-750

4,000 rpm / 3,900 xg



Microplate Holder, GLP-mw-750

4,000 rpm / 3,068 xg

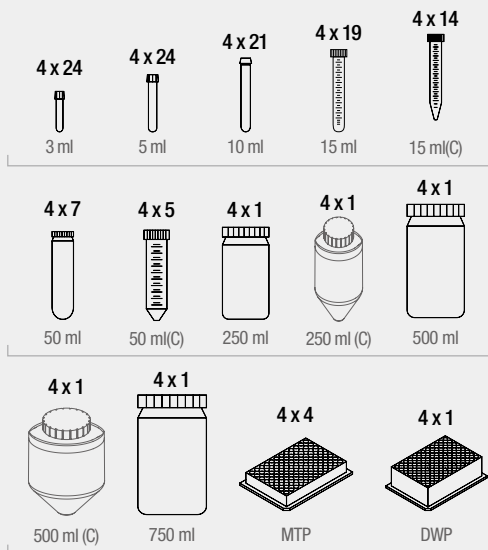

Tube Racks and Adaptors for GLB-750-750 / GLB-b750-750

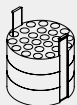

GAM-5-24(750)
24 x 3/5 ml

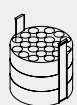

GAM-10-21(750)
21 x 10 ml



GAM-15-19(750)
19 x 15 ml



GAM-c15-14(750)
14 x 15 ml (C)

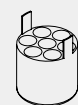

GAM-50-7(750)
7 x 50 ml



GAM-c50-5(750)
5 x 50 ml (C)



GAS-250(750)
250 ml

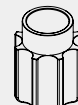

GAS-c250(750)
250 ml (C)



GAS-c500(750)
500 ml (C)

Swing-out Rotor, GRS-G-r250-4

4 loadings, 90° | for 1248, 1248R, 1236R, 1580, 1580R



Bucket, GLB-r250-r250
4,000 rpm / 3,134 xg



Microplate Holder, GLP-mw-r250
4,000 rpm / 2,737 xg

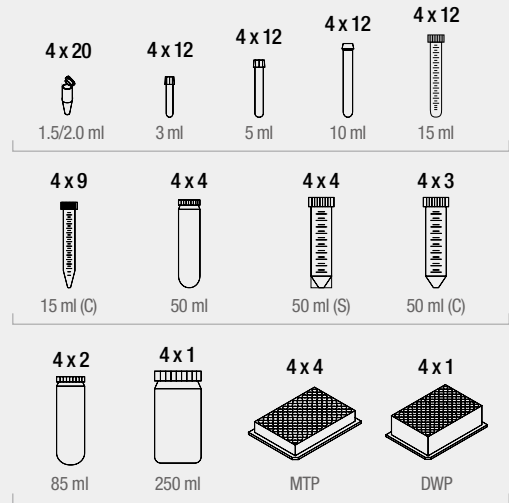

.....
Tube Racks and Adaptors
for GLB-r250-r250



Swing-out Rotor, GRS-G-250-4

4 loadings, 90° | for 1248, 1248R, 1236R, 1580, 1580R

Bucket, GLB-c250-250

5,000 rpm / 5,394 xg
one tube each



Bucket, GLB-60-250

5,000 rpm / 5,394 xg
one tube each



Bucket, GLB-250-250

5,000 rpm / 5,394 xg
one tube each

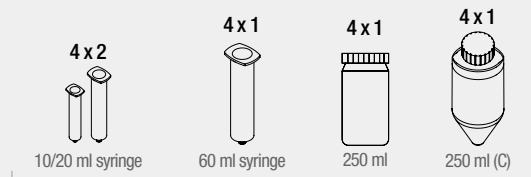

.....
Tube Racks and Adaptors
for GLB-60-250

* Custom-made upon syringe types.
Please inquire.



.....
Tube Racks and Adaptors
for GLB-d20/10-250

* Custom-made upon syringe types.
Please inquire.

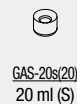

Swing-out Rotor, GRS-G-100-6

6 loadings, 90° | for 1248, 1248R, 1236R, 1580, 1580R



O-ring sealed Cap

Bucket, GLB-b100-100

4,000 rpm / 3,105 xg
one tube each

Bucket, GLB-10-8-100

4,000 rpm / 3,105 xg
8 tubes each

Bucket, GLB-bd15-100

4,000 rpm / 3,032 xg
2 tubes each



Bucket, GLB-b50-100

4,000 rpm / 3,032 xg
one tube each

Bucket, GLB-bdc15-100

4,000 rpm / 3,105 xg
2 tubes each

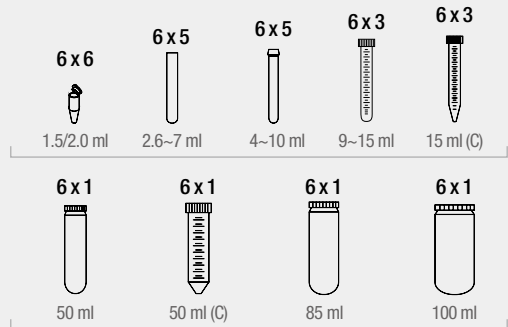

• • • • •
Tube Racks and Adaptors
for GLB-b100-100

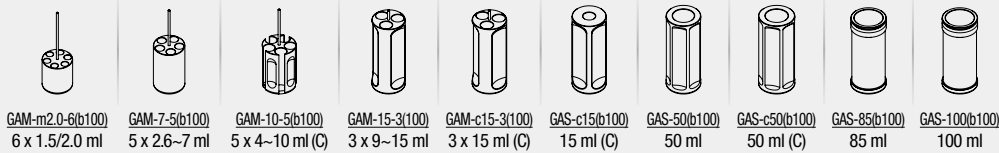

• • • • •
Tube Racks and Adaptors
for GLB-b50-100

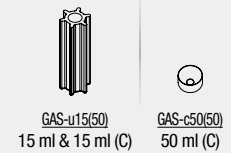

Fixed Angle Rotor, GRF-G-250-6

6 x 250/15 ml, 25° | for 1580R



Rotor, GRF-G-250-6

8,000 rpm / 9,395 xg (15 ml), 9,588 xg (250 ml)

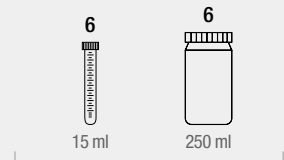

Fixed Angle Rotor, GRF-G-85-6

6 x 85 ml, 34° | for 1248, 1248R, 1236R, 1580, 1580R



Rotor, GRF-G-85-6

12,000 rpm / 17,709 xg (1580R)
10,000 rpm / 12,298 xg (1236R/1248/1248R/1580)

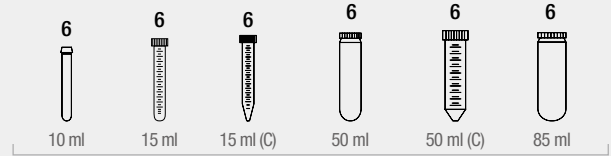

•••••
Tube Adaptors



Fixed Angle Rotor, GRF-G-50-8

8 x 50 ml, 30° | for 1248R, 1236R, 1580, 1580R



Rotor, GRF-G-50-8

15,000 rpm / 25,910 xg (1580R)
12,000 rpm / 16,582 xg (1236R/1248R/1580)

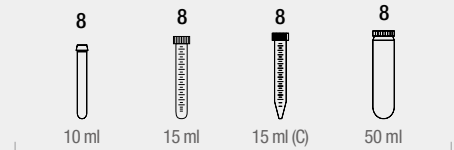

•••••
Tube Adaptors

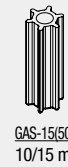

Fixed Angle Rotor, GRF-G-15-24

24 x 15 ml, 30° | for 1248R, 1236R, 1580R



Rotor, GRF-G-15-24

8,000 rpm / 7,370 xg (inner), 8,872 xg (outer)



Fixed Angle Rotor, GRA-G-15-24A

24 x 15 ml, 45° | for 1248, 1248R, 1236R, 1580, 1580R



Sleeve, GLB-15A-FA
4,000 rpm / 3,134 xg



Adaptors for
3 / 4 / 5 ml tubes

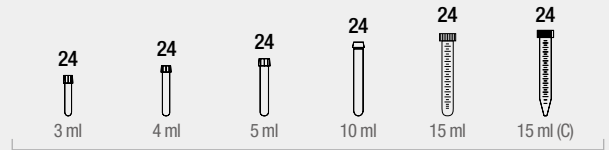

•••••
Tube Adaptors



GAS-3(15)
3 ml



GAS-4(15)
4 ml



GAS-5(15)
5 ml

Fixed Angle Rotor, GRF-G-m2.0-30

30 x 1.5/2.0 ml, 45° | for 1248, 1248R, 1236R, 1580, 1580R



Rotor, GRF-G-m2.0-30
15,000 rpm / 24,249 xg (1580R/1580)
12,000 rpm / 15,520 xg (1248R/1248/1236R)

Adaptors for
0.2 / 0.5 ml tubes

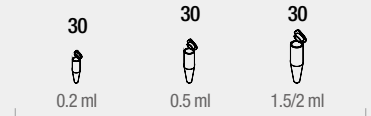

•••••
Tube Adaptors



GAS-m0.2(2)
0.2 ml



GAS-m0.5(2)
0.5 ml

Fixed Angle Rotor, GRF-G-s0.2-64

8-tube PCR strips (8-tube), 45° | for 1248, 1248R, 1236R, 1580, 1580R



Rotor, GRF-G-s0.2-64
12,000 rpm
9,434 xg (inner), 10,803 xg (outer)



PCR strip

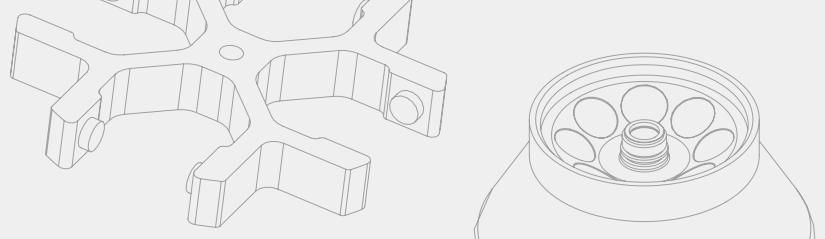

Ordering Information - Rotors and Buckets

Cat. No. & Description		Max. Capacity	Max. Speed		Bore Size (ϕ x L, mm) or (width, mm) or (hole diameter, mm)	Max. Height for tube fit (mm)	Radius (mm)
Rotors	Buckets & Microplate Holders		RPM	RCF (xg)			
Swing-out Rotor							
GRS-G-r750-4 Four-wing rectangular 750 ml swing-out rotor <i>Only for 1580 & 1580R</i>	GLB-r750-r750 a 750 ml rectangular bucket	4 x 500 ml conical	3,600	2,898	99 x 99 x 98	135	200.0
	GLB-500-r750 500 ml round bucket	4 x 500 ml	3,600	3,159	69.2 x 135	165	218.0
	GLP-mw-r750 Microplate holder	4 x 96 plate (MTP/DWP)	3,600	2,485	88 x 128.5 x 80	-	171.5
GRS-G-750-4 Four-wing round 750 ml swing-out rotor <i>Only for 1580 & 1580R</i>	GLB-750-750 a 750 ml round bucket	4 x 750 ml	4,000	3,667	99 x 101.5	142	205.0
	GLB-b750-750 a 750 ml O-ring sealed bucket	4 x 750 ml	4,000	3,667	99 x 101.5	130 (w/cap) 142 (w/o cap)	
	GLB-500-750 500 ml round bucket	4 x 500 ml	4,000	3,900	69.2 x 135	165	218.0
	GLP-mw-750 Microplate holder	4 x 96 plate (MTP/DWP)	4,000	3,068	88 x 128.5 x 80	-	171.5
GRS-G-r250-4 Four-wing rectangular 250 ml swing-out rotor	GLB-r250-r250 a 250 ml rectangular bucket	4 x 250 ml	4,000	3,134	86 x 70.3 x 102.5	130	175.2
	GLP-mw-r250 Microplate holder	4 x 96 plate (MTP/DWP)	4,000	2,737	88 x 128.5 x 80	-	153.0
GRS-G-250-4 Four-wing round 250 ml swing-out rotor	GLB-c250-250 250 ml conical bucket	4 x 250 ml conical	5,000	5,394	60.5 x 130.2	153	193.0
	GLB-250-250 250 ml round bucket	4 x 250 ml	5,000	5,394	62 x 109	153	
	GLB-60-250 60 ml syringe bucket	4 x 60 ml	5,000	5,394	31.5 x 130.2	165	
	GLB-d20/10-250 2 x 20 ml & 2 x 10 ml dual syringe bucket	4 x 2 x 20 ml/10 ml	5,000	4,752 (20 ml) 4,472 (10 ml)	22.5 x 100 (20 ml) 16 x 90 (10 ml)	132 (20 ml) 125 (10 ml)	170 (20 ml) 160 (10 ml)
GRS-G-100-6 Six-wing 100 ml O-ring sealed (b100) swing-out Rotor	GLB-b100-100 a 100 ml O-ring sealed bucket	6 x 100 ml	4,000	3,105	47 x 99	120 (w/cap) 130 (w/o cap)	173.6
	GLB-10-8-100 8 x 10 ml vacutainer bucket	6 x 8 x 10 ml	4,000	3,105	16 x 89	125	173.6
	GLB-b50-100 a 50 ml O-ring sealed bucket	6 x 50 ml	4,000	3,032	30.5 x 97	120 (w/ cap) 125 (w/o cap)	169.5
	GLB-bd15-100 2 x 15 ml O-ring sealed bucket	6 x 2 x 15 ml	4,000	3,032	17 x 96	123 (w/ cap) 127 (w/o cap)	
	GLB-bdc15-100 2 x 15 ml conical O-ring sealed bucket	6 x 2 x 15 ml conical	4,000	3,105	17 x 102.5	120 (w/ cap) 125 (w/o cap)	173.6
Fixed Angle Rotor							
GRA-G-15-24A Fixed angle rotor with 24 of 15 ml sleeves	GLB-15A-FA a 15 ml sleeve for holding 15 ml round or conical tubes	15 ml x 24	4,000	3,134	17.8 x 86.5	125 (120 for conical)	175.2
GRF-G-250-6 Fixed angle 250 ml / 15 ml rotor with aluminum lid <i>Only for 1580R</i>		6 x 250/15 ml	8,000	9,588 (250 ml) 9,395 (15 ml)	62 (250 ml) 17 (15 ml)	130 (250 ml) 120 (15 ml)	134 (250 ml) 131.3 (15 ml)
GRF-G-85-6 a Fixed angle 85 ml rotor with aluminum lid		6 x 85 ml	10,000 (except 1580R) 12,000 (1580R)	12,298 (except 1580R) 17,709 (1580R)	38.5	122	110
GRF-G-50-8 a Fixed angle 50 ml rotor with aluminum lid <i>for 1248R, 1236R, 1580, 1580R</i>		8 x 50 ml	12,000 (1248R/1236R/1580) 15,000 (1580R)	16,582 (1248R/1236R/1580) 25,910 (1580R)	29.5	120	103
GRF-G-15-24 Fixed Angle 15 ml Rotor with aluminum lid <i>Only for "R" Models</i>		24 x 15 ml	8,000	7,370 (inner) 8,872 (outer)	17.5	115	103 (inner) 124 (outer)
GRF-G-m2.0-30 a Fixed angle microtube rotor with aluminum lid		30 x 1.5/2.0 ml	12,000 (1248R/1248/1236R) 15,000 (1580R/1580)	15,520 (1248R/1248/1236R) 24,249 (1580R/1580)	11.1	52	96.4
GRF-G-s0.2-64 Fixed angle PCR strip rotor with aluminum lid		8 x PCR strips	12,000	9,434 (inner) 10,803 (outer)	6.5	16	58.6 (inner) 67.1 (outer)

a : Optional tube adaptors are available.

Related Products

Micro Centrifuges

Max. 13,500~17,000 rpm / 12,300~27,237 xg

0.2~2.0 ml, Microfilter tube, Cryotube



Clinical Centrifuges

Max. 4,000 rpm / 2,075~2,826 xg

1.5~100 ml, MTP



Large Capacity, High-Speed Centrifuges

Angle : Max. 10,000~22,000 rpm / 14,981~54,111 xg

Swing : Max. 4,000~5,000 rpm / 3,134~5,324 xg

0.2~1,000 ml, Blood Bags, MTP, DWP, FTP



Centrifugal Vacuum Concentrators

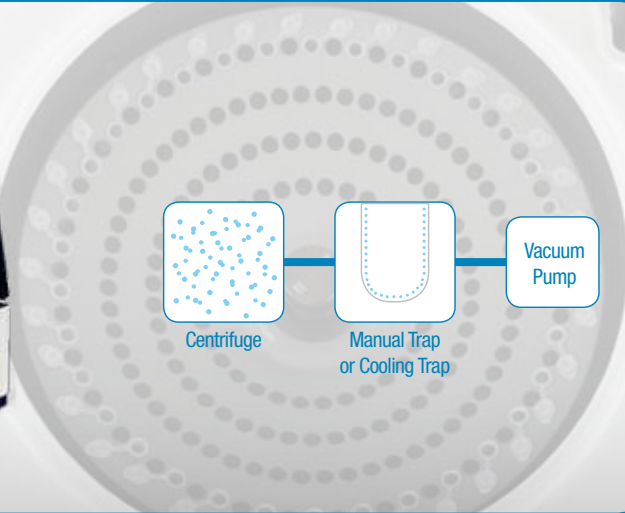
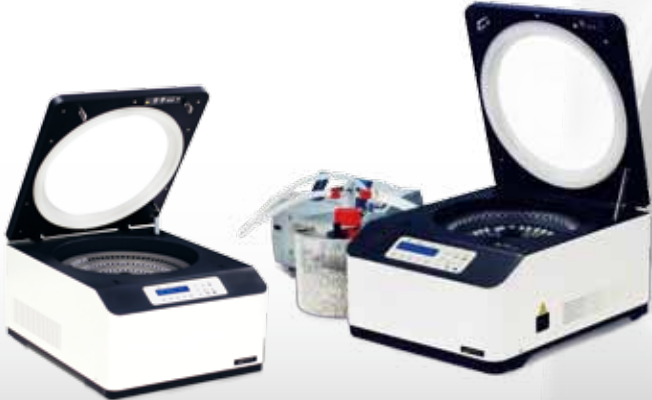

Automated Dry Purging Evaporation Concentrator

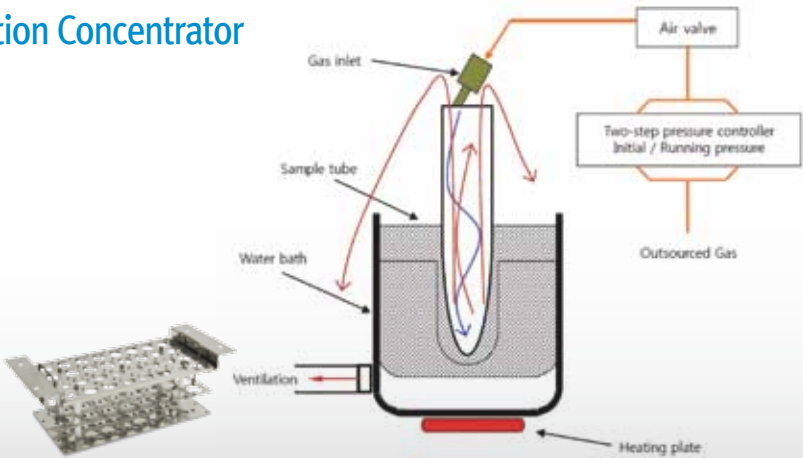

Laboratory Shakers



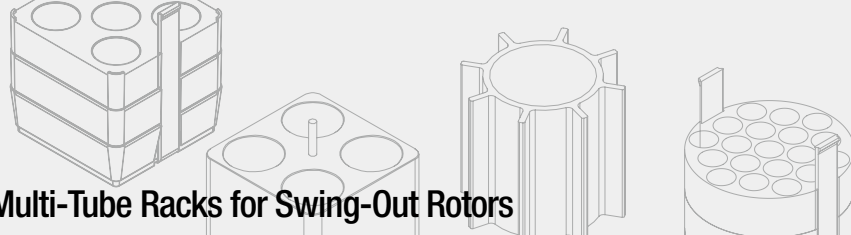

Ordering Information - Adaptors and Multi-Tube Racks for Swing-Out Rotors

Cat. No. & Description		Capacity	Hole Dimension (ϕ xL, mm)	Applicable Rotor & Bucket
Adaptors and Multi-tube Racks	with O-ring sealed Cap			
GAS-c500(r750) Adaptor for 500 ml conical	-	1 x 500 ml conical	98 x 94	GLB-r750-r750
GAS-c250(r750) Adaptor for 250 ml conical	-	1 x 250 ml conical	61 x 93	
GAS-250(r750) Adaptor for 250 ml	-	1 x 250 ml	62.5 x 87	
GAM-c50-5(r750) Multi-tube rack for 50 ml conical	-	5 x 50 ml conical	29.5 x 85	
GAM-50-8(r750) Multi-tube rack for 50 ml	-	8 x 50 ml	29.5 x 85	
GAM-c15-16(r750) Multi-tube rack for 15 ml conical	-	16 x 15 ml conical	17.5 x 85	
GAM-15-20(r750) Multi-tube rack for 15 ml	-	20 x 10/15 ml	17.2 x 85	
GAM-5-30(r750) Multi-tube rack for 3/5 ml	-	30 x 3/5 ml	13 x 56.5 (3 ml) 13 x 85 (5 ml)	GLB-750-750 GLB-b750-750
GAS-c500(750) Adaptor for 500 ml conical	-	1 x 500 ml conical	95.6 x 58	
GAS-c250(750) Adaptor for 250 ml conical	-	1 x 250 ml conical	60.5 x 125	
GAS-250(750) Adaptor for 250 ml	OK	1 x 250 ml	62.3 x 87	
GAM-c50-5(750) Multi-tube rack for 50 ml conical	OK	5 x 50 ml conical	29.2 x 88	
GAM-50-7(750) Multi-tube rack for 50 ml	OK	7 x 50 ml	29.2 x 87	
GAM-c15-14(750) Multi-tube rack for 15 ml conical	OK	14 x 15 ml conical	17 x 85	
GAM-15-19(750) Multi-tube rack for 15 ml	OK	19 x 15 ml	17.2 x 85	
GAM-10-21(750) Multi-tube rack for 10 ml	OK	21 x 10 ml	16 x 85	
GAM-5-24(750) Multi-tube rack for 3/5 ml	OK	24 x 3/5 ml	13.2 x 58 (3 ml) 13.2 x 85 (5 ml)	
GAS-250(r250) Adaptor for 250 ml	-	1 x 250 ml	62.5 x 87	
GAM-85-2(r250) Multi-tube rack for 85 ml & 15 ml	-	2 x 85 & 15 ml	17 x 86.5 (15 ml) 38.5 x 86.5 (85 ml)	
GAM-c50-3(r250) Multi-tube rack for 50 ml conical	-	3 x 50 ml conical	30.5 x 90	
GAM-50-4(r250) Multi-tube rack for 50 ml	-	4 x 50 ml	30.2 x 90	
GAM-s50-4(r250) Multi-tube rack for 50 ml skirted	-	4 x 50 ml skirted	31.4 x 65	
GAM-c15-9(r250) Multi-tube rack for 15 ml conical	-	9 x 15 ml conical	17.5 x 90	
GAM-15-12(r250) Multi-tube rack for 10/15 ml	-	12 x 10/15 ml	17.5 x 90	
GAM-5-12(r250) Multi-tube rack for 3/5 ml	-	12 x 3/5 ml	13.5 x 58 (3 ml) 13.5 x 80 (5 ml)	
GAM-m2.0-20(r250) Multi-tube rack for 1.5/2.0 ml	-	20 x 1.5/2.0 ml	11.3 x 39	GLB-60-250 GLB-d20/10-250
GAS-60s(60) Adaptor for 60 ml syringe	-	1 x 60 ml syringe	Custom Size	
GAS-20s(20) Adaptor for 20 ml syringe	-	1 x 20 ml syringe		
GAS-10s(10) Adaptor for 10 ml syringe	-	1 x 10 ml syringe		
GAS-c50(50) Adaptor for 50 ml conical	OK	1 x 50 ml conical	29.5 x 15.6	GLB-b50-100
GAS-u15(50) Adaptor for 15 ml round & conical	OK	1 x 15 ml round & conical	17.3 x 87	
GAS-100(b100) Adaptor for 100 ml	OK	1 x 100 ml	44.2 x 93	GLB-b100-100
GAS-85(b100) Adaptor for 85 ml	OK	1 x 85 ml	38.5 x 96.4	
GAS-c50(b100) Adaptor for 50 ml conical	OK	1 x 50 ml conical	30 x 100	
GAS-50(b100) Adaptor for 50 ml	OK	1 x 50 ml	29.5 x 95.9	
GAS-c15(b100) Adaptor for 15 ml conical	OK	1 x 15 ml conical	17.2 x 106.5	
GAM-c15-3(100) Multi-tube rack for 15 ml conical	-	3 x 15 ml conical	17.2 x 106.5	
GAM-15-3(100) Multi-tube rack for 9~15 ml	-	3 x 9 ~ 15 ml	17.2 x 105	
GAM-10-5(b100) Multi-tube rack for 4~10 ml	OK	5 x 4 ~ 10 ml	16 x 60	
GAM-7-5(b100) Multi-tube rack for 2~7 ml	OK	5 x 2.6~7 ml	13.5 x 60	
GAM-m2.0-6(b100) Multi-tube rack for microtube	OK	6 x 1.5/2.0 ml	11 x 39	



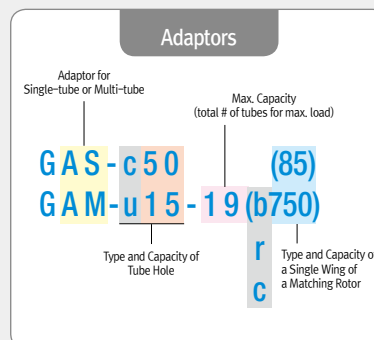
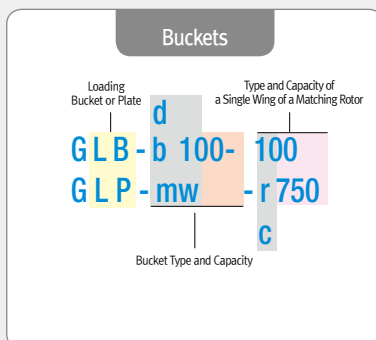
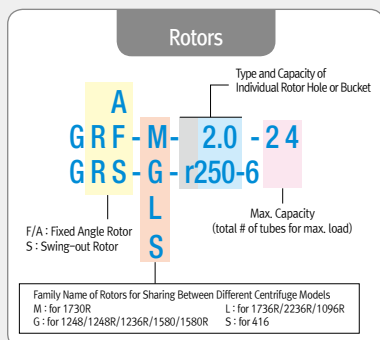

Catalog Numbering Rule of Rotors and Accessories







Type Symbol of Tube or Bucket

- No symbol : round type
- r : rectangular type
- c : conical type
- d : dual hole type
- b : O-ring sealed bucket
- u : universal for both of round & conical tube
- mw : for multiwell plate

Ordering Information - Adaptors for Fixed Angle Rotors

Cat. No. & Description	Capacity	Hole Dimension (ϕ x L, mm)	Applicable Rotor & Bucket
Adaptors and Multi-tube Racks			
GAS-5(15) Adaptor of 15 ml sleeve for 5 ml	1 x 5 ml	13.5 x 85	GLB-15A-FA 
GAS-4(15) Adaptor of 15 ml sleeve for 4 ml	1 x 4 ml	13.5 x 65	
GAS-3(15) Adaptor of 15 ml sleeve for 3 ml	1 x 3 ml	13.5 x 61	
GAS-c15(50) Adaptor for 15 ml conical	1 x 15 ml conical	17 x 105	GRF-G-50-8 
GAS-15(50) Adaptor for 15 ml	1 x 10/15 ml	17 x 94	
GAS-c50(85) Adaptor for 50 ml conical	1 x 50 ml conical	29.5 x 98	GRF-G-85-6 
GAS-50(85) Adaptor for 50 ml	1 x 50 ml	29 x 95	
GAS-c15(85) Adaptor for 15 ml conical	1 x 15 ml conical	17 x 98	
GAS-15(85) Adaptor for 15 ml	1 x 10/15 ml	17 x 94	
GAS-m0.5(2) Adaptor for 0.5 ml	1 x 0.5 ml	8 x 31	GRF-G-m2.0-30 
GAS-m0.2(2) Adaptor for 0.2 ml	1 x 0.2 ml	6.5 x 23	

Ordering Information - Main Equipment

		1248	1248R	1236R	1580	1580R
Main equipment						
Cat. No.	for 220V	GZ-1248	GZ-1248R	GZ-1236R	GZ-1580	GZ-1580R
	for 110V	GZ-1248-110	GZ-1248R-110	GZ-1236R-110	GZ-1580-110	GZ-1580R-110
Max. RPM/RCF	Fixed angle	12,000/15,520 xg	12,000/16,582 xg		15,000/24,249 xg	15,000/25,910 xg
	Swing-out	5,000/5,394 xg				
Max. capacity	Fixed angle	6 x 85 ml, 30 x 1.5/2.0 ml				6 x (250 & 15 ml), 30 x 1.5/2.0 ml
	Swing-out	4 x 250 ml / 250 ml conical, 48 x 15 ml, 4 x 4 MTPs			4 x 750 ml, 80 x 15 ml, 4 x 4 MTPs	
Temp. range (°C)	-	-20 ~ +40		-	-20 ~ +40	
FAST COOL button	-	Yes		-	Yes	
Time control	Pulse, Timed < 100 min or continuous	Pulse, Timed < 10 hr or continuous			Pulse, Timed < 100 min or continuous	Pulse, Timed < 10 hr or continuous
Time at set speed				Yes		
Noise level (dB)				≤ 60		
ACC / DEC ramps				9/10		
Program save				100		
Rotor identification				Automation		
Imbalance cut-off				Yes		
Safety lid lock / Key lock				Yes / Yes		
Automatic lid release at completion	Yes	-		Yes	-	
Lid drop protection				Yes		
Variable end alarms				Yes		
Motorized lid closing				Yes		
Power requirement (220V)	900 VA	2.5 kVA		1.5 kVA	2.5 kVA	
Dimension (W x D x H, mm)	475 x 561 x 330	655 x 620 x 357	473 x 600 x 840	540 x 650 x 380	770 x 650 x 390	
Weight without rotor (kg)	40	78	110	57	93	
CE mark				Yes		

GYROZEN®

Tel : +82-2-3452-7736 | info@gyrozen.com | www.gyrozen.com
30-12 Gyeryong-ro 141beon-gil, Yuseong-gu, Daejeon, 34187, Rep. of KOREA

C99DC10104-15